

***QUARTZ* 50**

07 2020



Use and maintenance



Warning! Please read the instructions before use.

INTRODUCTORY COMMENT

Thank you for having chosen our machine. This floor cleaning machine is used for the industrial and civil cleaning and is able to clean any type of floor. During its advance movement, the combined action of the brushes and the detergent solution removes the dirt which is aspirated through the rear suction assembly, giving a perfectly dry surface.

The machine must be used only for such purpose. It gives the best performance if it is used correctly and maintained in perfect efficiency. We therefore ask you to read this instruction booklet carefully whenever difficulties arise in the course of the machine's use. In case of need, we ask you to contact our service department for all advice and servicing as may prove necessary.

CAUTION This machine is for indoor use only

CAUTION This machine shall be stored indoors only.

SUMMARY

INTRODUCTORY COMMENT	3	WORK	14
GENERAL RULES OF SAFETY	4	Manual mode work	14
Transfer	4	Speed adjustment, forward and backward.....	14
Storage and disposal	4	Detergent solution flow adjustment	14
Correct use.....	4	Automatic mode work	15
Maintenance	4	Silent mode suction motor.....	15
Transporting the machine.....	4	Stand-by mode.....	15
General rules of the batteries.....	4	Horn	15
TECHNICAL DESCRIPTION.....	5	Parking brake	15
DISPLAY AND CONTROLS LEGEND.....	6	Brushes motor overload protection system	15
MACHINE LEGEND.....	6	Overflow system.....	15
READING THE DISPLAY.....	7	MACHINE STOP AFTER CLEANING OPERATION	16
Display when switching on.....	7	Break washing mode.....	16
Software release.....	7	DAILY MAINTENANCE.....	16
Controls display.....	7	Draining and cleaning the recovery tank.....	16
Hourmeter.....	7	Cleaning the suction filter.....	16
Water system.....	7	Automatic disassembling of the brush.....	16
Battery settings.....	7	Draining and cleaning the detergent tank (3SD)	16
NAVIGATION CONTROLS.....	8	Draining and cleaning the solution tank.....	16
General settings	8	Cleaning the brush.....	17
Select the display language	8	Cleaning the squeegee.....	17
Change the battery setting	8	WEEKLY MAINTENANCE.....	17
Change the water system.....	8	Rear squeegee rubber check.....	17
Display tune	8	Cleaning the squeegee hose.....	17
Display brightness.....	8	Cleaning the outer filter and the solution tank	17
MANUAL SYMBOLS.....	9	Squeegee height adjustment.....	17
OPTIONAL EQUIPMENTS.....	9	Cleaning the filter (3S or 3SD version).....	17
BEFORE THE USE	10	TWO-MONTHLY MAINTENANCE.....	18
Handling of the packed machine	10	Front squeegee rubber check.....	18
Unpacking and manually moving the machine.....	10	SIX-MONTHLY MAINTENANCE.....	18
Access to the battery van	10	Splash guards rubber check	18
Installing the batteries.....	10	TROUBLESHOOTING GUIDE.....	18
Battery charger.....	10	The suction motor does not work	18
On-board battery charger (optional)	10	The brush motor does not work.....	18
Battery charge level indicator	10	The traction motor does not work.....	18
Lifting the recovery tank.....	11	The solution is not spilled on the brush.....	18
Battery charging	11	The machine does not clean properly	19
Battery charging using the on-board charger (optional)	11	The squeegee does not dry properly.....	19
Assembling the brush.....	11	Excessive foam production.....	19
Assembling and disassembling the splashguards.....	11	PROGRAMMED MAINTENANCE	19
FLOOR CLEANING	12	Periodic ordinary maintenance chart.....	19
Connecting the battery connector and switching on the machine..	12		
Recovery tank	12		
Detergent solution tank	12		
3S "Solution Saving System" (optional)	12		
3SD "Solution Saving System Dispenser" (optional)	12		
Water carriage level selection – 3S and 3SD System.....	13		
Detergent solution percentage selection – 3SD System.....	13		
Ozone selection (optional).....	13		
Working with ozone (optional).....	13		

GENERAL RULES OF SAFETY

- The rules below have to be followed carefully in order to avoid injury to the operator and damage to the machine.
- Read the labels carefully on the machine. Do not cover them for any reason and replace them immediately if damaged.
- ATTENTION: The machine must be used exclusively by authorized staff that have been instructed on its correct and proper use.
- ATTENTION: Do not use the machine on areas having a higher gradient than the one stated on the number plate.
- ATTENTION: The machine is not to be used by persons, children included, with reduced physical, sensorial or mental capabilities, or with lack of experience or knowledge, unless they could benefit, through the intermediation of a responsible person for their safety, by a supervision or instructions concerning to its use.
- During the operation of the machine, pay attention to other people and especially to the children.
- Children shall not play with the machine.
- Children cannot carry out cleaning and maintenance of the machine.

TRANSFER

- Do not strike shelveings or scaffoldings where there is danger of falling objects.
- Leaving the machine in parking position, take off the key.
- Do not use the machine as a means of transport.
- Adapt the working speed to the adhesion conditions: particularly, slow down before narrow curves have to be faced.

STORAGE AND DISPOSAL

- Storage temperature: between 0°C and +55°C (32°F and 131°F).
- Perfect operating temperature: between 0°C and +40°C (32°F and 104°F).
- The humidity should not exceed 95%.
- Provide for the scrapping of the material of normal wear following strictly the respective rules.
- The batteries need to be removed from the machine before its scrapping.
- When your machine has to stop activity, provide for the appropriate waste disposal of its materials, especially oils, batteries and electronic components, and considering that the machine itself has been, where possible, constructed using recyclable materials.

CORRECT USE

- Do not use the machine on surfaces covered with inflammable liquids or dusts (for example hydrocarbons, ashes or soot).
- In case of fire, use a powder based fire-extinguisher. Do not use water.
- Do not use the machine in explosive atmosphere.
- The machine has to carry out simultaneously the operations of washing and drying. Different operations must be carried out in restricted areas prohibited to non-authorized personnel and the operator has to wear suitable shoes.
- Signal the areas of moist floors with suitable signs.
- Do not mix different detergents, avoiding harmful odours.
- Avoid brushes operation when the machine is standing still in order to prevent floor damages.

MAINTENANCE

- If the machine does not work properly, check by conducting simple maintenance procedures. Otherwise, as for technical advice from an authorized assistance centre.
- For any cleaning and/or maintenance operation take off the power supply from the machine.
- Where parts are required, ask for ORIGINAL spare parts from the distributor and/or from an authorized dealer.
- Use only ORIGINAL brushes indicated in the paragraph "RECOMMENDED BRUSHES".
- Do not take off the protections which require the use of tools for their removal.
- Do not wash the machine with direct water jets or with high water pressure nor with corrosive material.
- Every 200 working hours have a machine check by an authorized service department.
- Before using the machine, check that all panels and coverings are in their position as indicated in this use and maintenance catalogue.
- Restore all electrical connections after any maintenance operation.

TRANSPORTING THE MACHINE

WARNING: Before transporting the machine on an open truck or trailer, make sure that:

- All tanks are empty.
- Recovery tank cover is latched securely.
- The machine is tied down securely.
- The machine's electromagnetic brake is engaged (not manually overridden).

GENERAL RULES OF THE BATTERIES



- At any intervention on the batteries, use suitable acid-proof gloves and glasses.
- Do not smoke near the batteries and do not approach them with free flames.
- Check that a fire-extinguisher is available on site.
- Be very careful in case of leakages or liquid outlets because corrosive.
- Do not place any metallic tools onto the batteries. Risk of short circuit!
- It is compulsory to hand over exhaust batteries, classified as dangerous waste, to an authorized institution according to the current laws.

TECHNICAL DESCRIPTION

Working width	mm	508
Squeegee width	mm	685
Work capacity up to	m ² /h	2032
Brush diameter	mm	508
Brush rpm	rpm	140
Brush pressure	kg	22
Brush motor	W	380
Suction motor	W	490
Suction motor depression	mbar	120
Traction motor	W	280
Drive type		automatic
Maximum gradient	%	10
Solution tank	l	58
Recovery tank	l	80
Machine length	mm	1220
Machine height	mm	649
Machine width (without squeegee)	mm	698
Machine weight (empty tanks, without batteries)	kg	153
Machine gross weight (in conformity with the EN 60335-2-72 art. 5.z102)	kg	74
Battery voltage	V	24
Battery capacity	Ah ₅	110
Battery van dimensions	mm	365 x 338 x 290
Acoustic pressure level (in conformity with the EN 60335-2-72 art. 60704-1) Lpa	dB	/
Vibration to the hand level	m/s ²	/
Uncertainty k	m/s ²	/
Class		III
Protection level	IP	23
Packed machine weight	kg	/
Packing dimensions (LxPxH)	cm	140 x 75 x 148,5

DISPLAY AND CONTROLS LEGEND

1. DISPLAY
 2. CLEANING MODE SELECTION BUTTON:
 - AUTOMATIC
 - MANUAL
 - BREAK WASHING
 3. WORKING MODE SELECTION BUTTON
 - STANDARD
 - 3S
 - 3SD
 4. UP/DOWN AND UNLOCK, BRUSH BASE BUTTON
 5. SUCTION MOTOR BUTTON
 - ON/OFF
 - SILENT MODE
 6. OPEN/CLOSE SOLENOID VALVE
 7. SOLUTION LEVEL BUTTON (ONLY FOR 3S/3SD)
 8. MAXIMUM SPEED INCREASE BUTTON
 9. MAXIMUM SPEED DECREASE BUTTON
-
10. SPEED ADJUSTMENT KNOB
 11. OFF/ON KEY SWITCH
 12. FORWARD/BACKWARD SPEED LEVER
 13. HORN

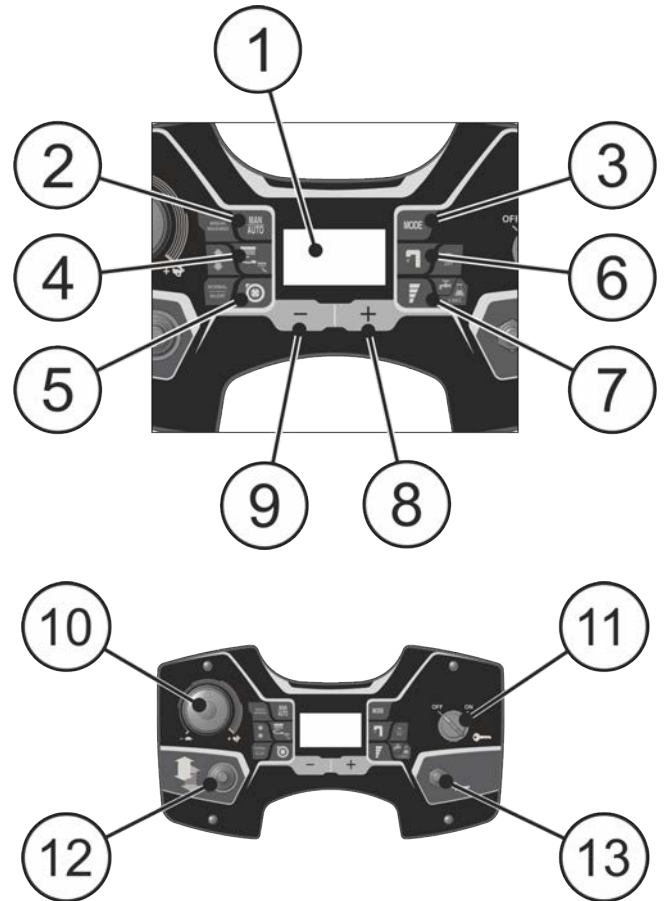

MACHINE LEGEND

- | | |
|---|--|
| <ol style="list-style-type: none"> 1. RECOVERY TANK 2. SQUEEGEE HOSE 3. STEERING WHEEL 4. DASHBOARD AND CONTROLS 5. SQUEEGEE LEVER 6. WATER LEVEL HOSE 7. DRIVE PEDAL 8. SIDE BROOMS SUPPORT LOCKS (OPTIONAL) 9. DETERGENT SOLUTION FILTER 10. WATER VALVE LEVER 11. DETERGENT SOLUTION LOAD CAP (ONLY FOR 3SD - OPTIONAL) 12. TANK LIFTING HANDLES | <ol style="list-style-type: none"> 13. BATTERY CONNECTOR 14. SOLUTION LOAD CAP 15. BATTERY VAN CLOSING LEVER 16. SUCTION MOTOR HOSE 17. DRAIN HOSE 18. SOLUTION TANK 19. FOOTBOARD/OPERATOR PRESENCE DEVICE 20. REAR WHEELS 21. SQUEEGEE ASSEMBLY 22. BRUSHES BASE ASSEMBLY 23. TRACTION ASSEMBLY |
|---|--|

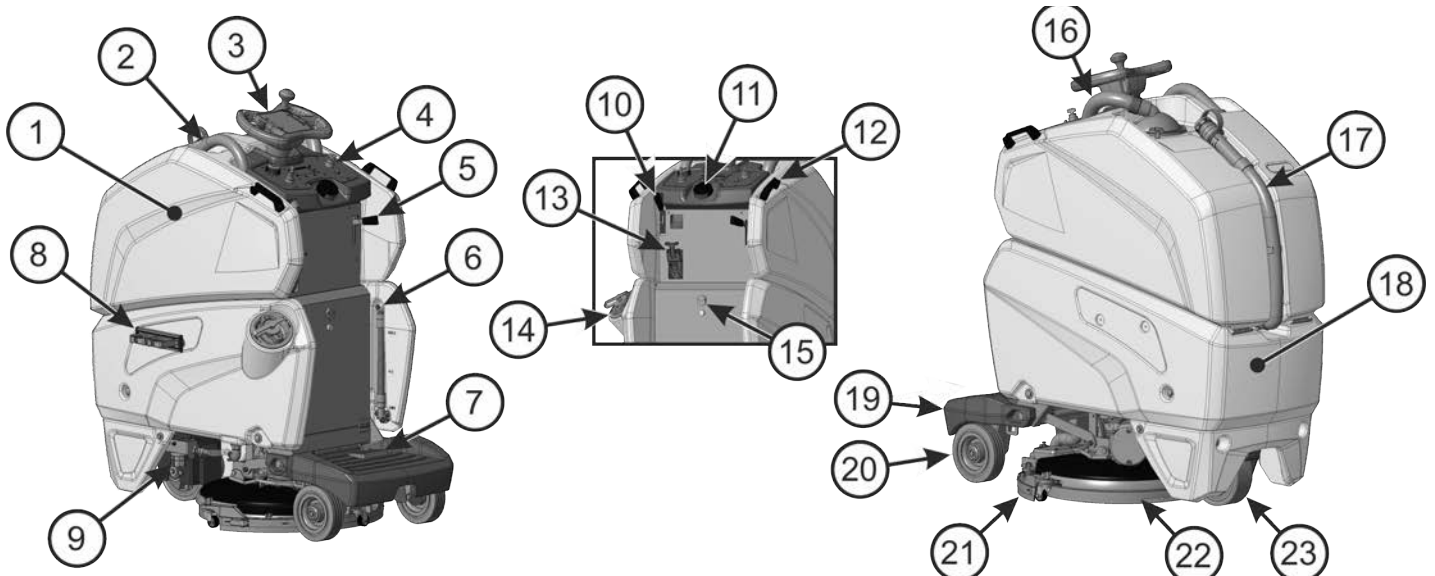

READING THE DISPLAY

DISPLAY WHEN SWITCHING ON

When the machine is switched on the display shows the following screen.



The next screen shows:

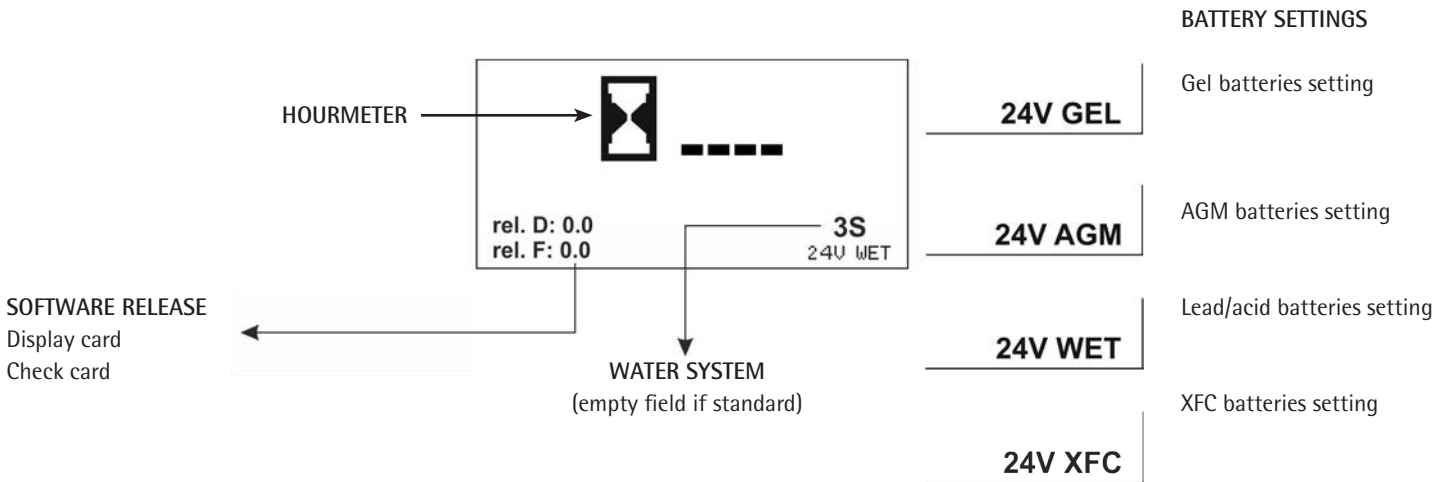

CONTROLS DISPLAY

Standard mode

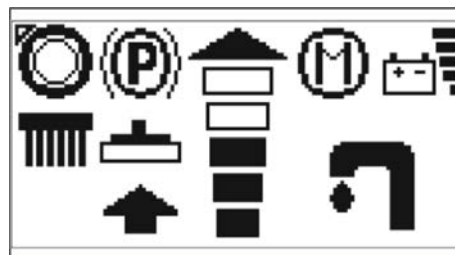

Parking brake on		Brush base up		Maximum speed level indicator		Standard mode selection	
Automatic mode		Brush base down				Solenoid valve on	
Manuall mode		Brush base on				Solenoid valve off	
Battery charge level						3S mode selection	3S
						3SD mode selection	3SD
Suction motor off		Squeegee up				Ozone mode selection	
Suction motor on		Squeegee down				Ozone+3S mode selection	
Suction motor silent mode						Ozone+3SD mode selection	

NAVIGATION CONTROLS



GENERAL SETTINGS

To enter the settings menu, use the dashboard buttons and proceed as follows:

1. Keep buttons (1) and (5) pressed simultaneously
2. Turn the key switch on
3. When "INSERT PASSWORD:0" is shown on the display, press button (2) to confirm.

Once entered the GENERAL SETTINGS it will be possible to change the following settings by simply scrolling through the menu using buttons (1) and (3).

SELECT THE DISPLAY LANGUAGE

English is the default language, it is possible to switch to Italian.

To select the language scroll with the button (1) and (3) until is shown "Language". Press buttons (4) and (5) to select the language. Press button (2) to confirm.

CHANGE THE BATTERY SETTING

Once entered the general settings it is possible to set the machine depending on the batteries installed (AGM / GEL / LEAD-ACID / XFC).

To select the setting scroll using buttons (1) and (3) until is shown "Battery". Press buttons (4) and (5) to select the battery type. Press button (2) to confirm.

CHANGE THE WATER SYSTEM

Once entered the general settings it is possible to set the type of water system which the machine is provided of (standard, 3S, 3SD, O3, O3+3S, O3+3SD).

To select the water system scroll with the button (1) and (3) until is shown "Options". Press buttons (4) and (5) to select the water system. Press button (2) to confirm.

DISPLAY TUNE

Once entered the general settings it is possible to set the display tune. Scroll with the button (1) and (3) until is shown "Display tune". Press buttons (4) and (5) to select the tune. Press button (2) to confirm.

DISPLAY BRIGHTNESS

Once entered the general settings it is possible to set the display brightness.

Scroll with the button (1) and (3) until is shown "Display brightness". Press buttons (4) and (5) to select the brightness. Press button (2) to confirm.



A wrong setting could damage the batteries irreparably.

ALWAYS verify that the correct parameter is set..

The battery setting can be seen when turning on the machine (see "SETTING THE BATTERIES or READING THE DISPLAY").

MANUAL SYMBOLS



Open book symbol.
Indicates that the operator has to read the manual before the use of the machine.



Open book symbol.
For the proper functioning of the on-board battery recharger (optional), read the manual of the constructor.



Warning symbol.
Read carefully the sections marked with this symbol, for the safety of both the operator and the machine.



Warning symbol.
Risk of acid leaking from the batteries.



This symbol points that it is imperative to disconnect the wiring from the batteries using the connector, before any operation on the machine.



Obligation symbol requiring to wear the safety glasses.



Obligation symbol requiring to wear the safety gloves.



Symbol preceding an information about the correct use of the machine.



Symbol indicating operations to be carried out only by qualified personnel.

OPTIONAL EQUIPMENTS



TELEMATICS

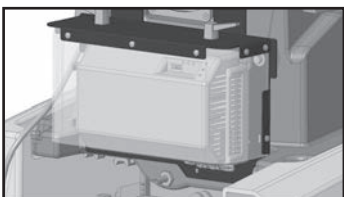

ON-BOARD BATTERY CHARGER



3S SYSTEM

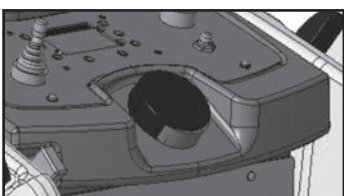

3SD SYSTEM

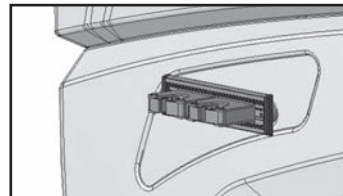

SIDE BROOMS SUPPORTS

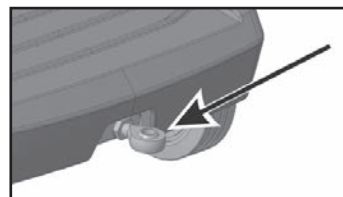

TROLLEY LOCK

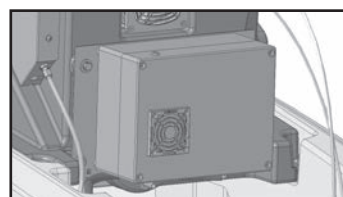

OZONE SYSTEM O3

BEFORE THE USE

HANDLING OF THE PACKED MACHINE

The machine is supplied with suitable packing foreseen for fork lift truck handling.

For the package dimensions please look at the "TECHNICAL DESCRIPTION" table.



Do not place more than 2 packagings on top of each other.

UNPACKING AND MANUALLY MOVING THE MACHINE

1. Remove the external packing.
2. Unscrew the supports (1+2) that fix the machine to the platform.

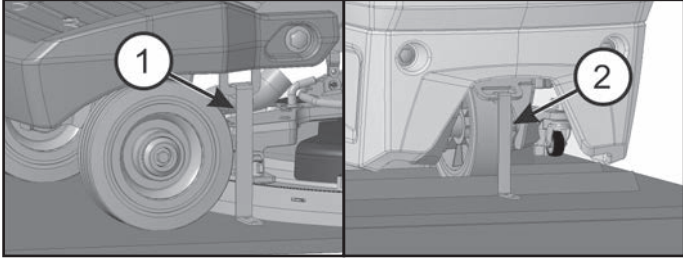

3. Before releasing the machine from the platform it is necessary to unlock the parking brake that stops the traction wheel. To do that open the lever (3). The red position stands for the braked machine, the green position stands for the unlocked parking brake..

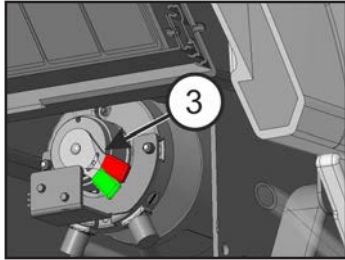

4. Move the machine backwards, as indicated in the picture, avoiding heavy contacts against mechanical parts



5. Restore the electric brake bringing back the lever on the "red" position as showed in paragraph 3.

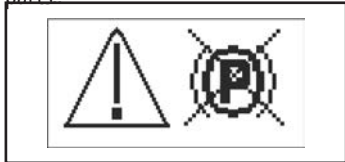

Keep the platform and the brackets for an eventual transport. The portable slope is not included in the packaging.

ACCESS TO THE BATTERY VAN

The machine is provided with an extractable compartment for the batteries installment. To accede it turn the knob (1) and pull the compartment (2) out.

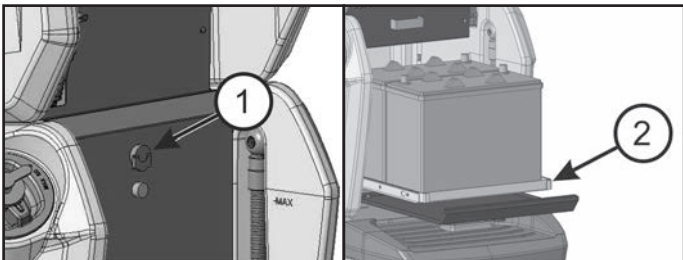

INSTALLING THE BATTERIES

The standard machine is provided with the batteries set on lead/acid.

For different settings see chapter "BATTERY SETTINGS".

The machine requires the use of serial connected batteries placed in their dedicated van. Batteries must be handled using suitable lifting

equipment (due to weight, considering the type of batteries chosen, and coupling system).

The batteries must be in accordance with CEI 21-5 Norms.



Strictly follow manufacturer/distributor indications for the maintenance and charge of the batteries. All installation and maintenance operations must be executed by specialized staff, using suitable protection accessories.

For batteries installation it is necessary to reach the battery compartment as indicated under paragraph "ACCESS TO THE BATTERY VAN".

1. Put the batteries in the housing.

2. Connect the terminals, respecting the polarities, avoiding contact with other parts that could create short circuit, covering the battery poles with terminal protections.

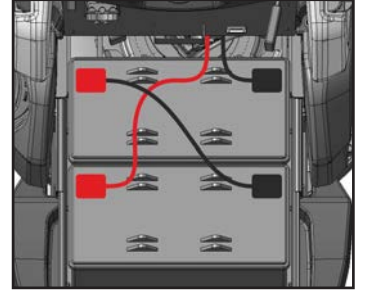

BATTERY CHARGER



Make sure that the battery charger is suitable for the installed batteries both for their capacities and type (lead/acid or GEL and equivalent).

In the plastic bag containing the use and maintenance you will find the coupling connector for the recharger. It must be assembled onto the cables of your charger, following the instructions given by the manufacturer.

ON-BOARD BATTERY CHARGER (OPTIONAL)

If the machine is equipped with the incorporated battery charger (see under "OPTIONAL EQUIPMENTS") please refer to the instructions of the constructor of this equipment what the charging operations occur.

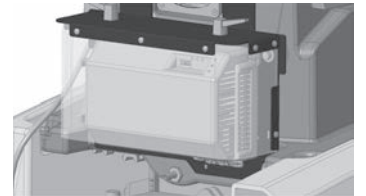

The battery charger is connected directly to the battery poles.

During the charge a system is activated that does not allow the machine functioning.

The battery charger cable have a maximum length of 2 meters and must be connected to a single phase plug CEE 7/7 type.

BATTERY CHARGE LEVEL INDICATOR

The battery charge level is displayed with its related symbol (see "CONTROLS DISPLAY").



When the last segment of charge starts blinking, the battery is almost low and the suction and brushes functions are disabled.



When even the last segment of charge turns off, the battery is completely low and the machine stops.

LIFTING THE RECOVERY TANK

For some ordinary maintenance operations, like the battery charge, it could be necessary to open the recovery tank.

Grab the handles (1) and lift it.

Open it to its maximum extension in order to lock the opening system.. Move the lever (2) to unlock it, then close the tank keeping a hand on the handle (1).

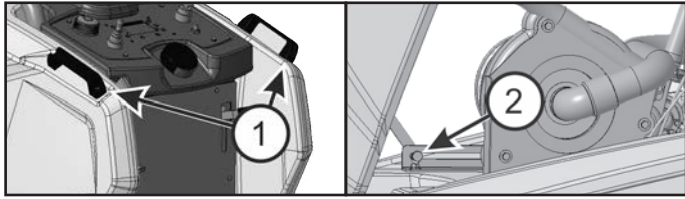

BATTERY CHARGING



1. Plug the connector (2) of the battery charger into the battery connector (1).
2. Proceed with the charge, keeping the recovery tank open

Once that the battery recharging is completed:

3. Disconnect the connector of the battery charger from the battery connector (1).
4. Connect now the machine connector (3).

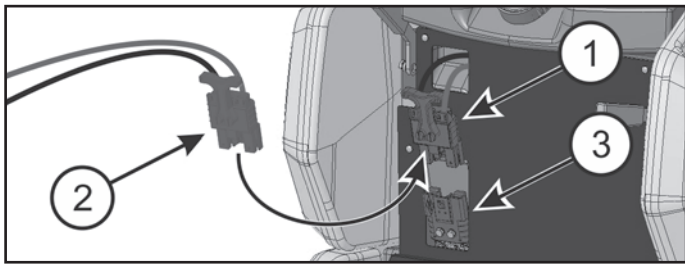

BATTERY CHARGING USING THE ON-BOARD CHARGER (OPTIONAL)



Take the machine to a plain surface near a power plug.

1. Turn off the machine using the key switch.
2. Insert the plug into the main socket.
3. Proceed with the charge keeping the recovery tank lifted (see paragraph "ACCESS TO THE BATTERY COMPARTMENT" in "BEFORE USE").
4. Do not take off the plug from the main socket until the indication of the end of charge is displayed.

At the end of the charge, take off the plug from the main socket.

Never charge the batteries with a non suitable battery charger. Carefully follow the instructions provided by the battery charger and the batteries manufacturers.

NOTE: Never leave the batteries completely discharged for long periods of time even if the machine is not used. In case of traditional batteries, please check the electrolyte level every 20 charging cycles and eventually fill them up with distilled water. Never leave the batteries discharged for more than two weeks.

If lead/acid batteries are installed there could be the risk of gas exhalations and emission of corrosive liquids.

Fire danger: do not approach with free flames.

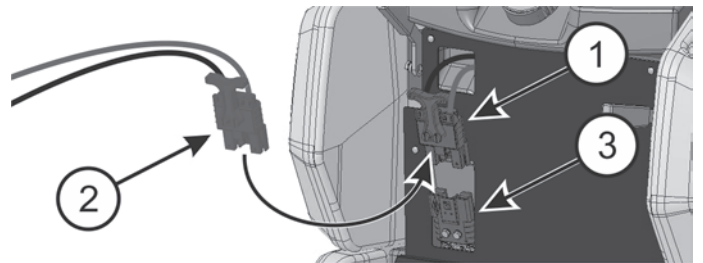

ASSEMBLING THE BRUSH

To assemble the brush it is necessary to have the brush base lifted from the floor. If it is not in such position, proceed as follows:

Without having an operator aboard, turn the key to switch on the display, then after 3 seconds, automatically all the working assemblies will reset themselves and lift from the floor.

Turn off the machine using the key switch.



With the brush base lifted, manually rotate the brush until the central screw, where to fix the support and to lock the brush, can be seen. Secure the brush as shown in the picture.

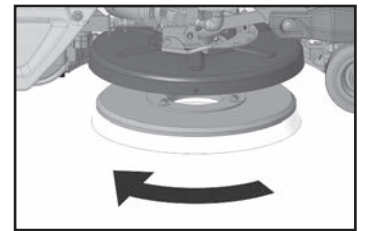

Use only brushes provided with the machine or the ones specified on the "BRUSHES and OPTIONAL" manual. Using other brushes could compromise the good cleaning.

ASSEMBLING AND DISASSEMBLING THE SPLASHGUARDS

The two splashguards must be assembled on the brush base cover.

1. with the brush base lifted, rotate the brush until the locking screw where the supports have to be fixed, is seen.

2. Insert the metal supports inside the dedicated housings on the rubber. Place the round hole to the plain end of the support on the screw in front of the cover. Secure then the supports tightening the nut.

3. Screw the screws on the rear part of the cover, on the free end of the metal supports and the locks. The operation has to be made for both the splash guards rubbers.

With the brush on, the splash guard rubber has to slightly touch the floor.

To disassemble the supports just repeat these operations backwards.

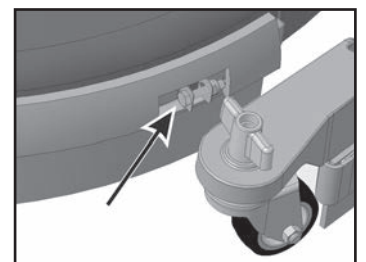
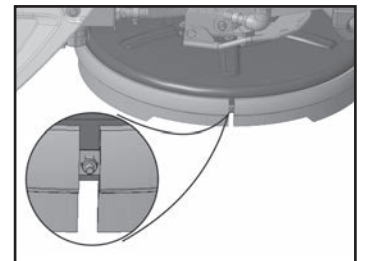

FLOOR CLEANING



CONNECTING THE BATTERY CONNECTOR AND SWITCHING ON THE MACHINE

Once that the battery charging has been completed:

1. Disconnect the connector (2) of the battery charger from the battery connector (1).
2. Connect then the battery connector (1) to the machine connector (3).

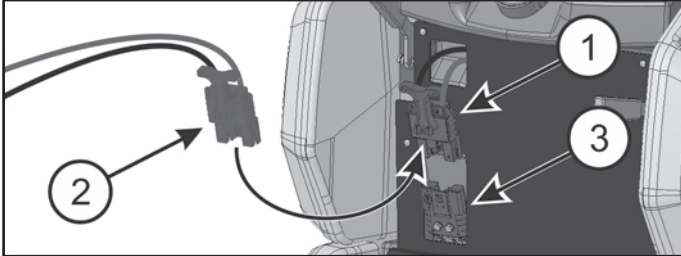

RECOVERY TANK

Check that the suction filter cap (1) is properly secured after turning the levers and that is properly connected to the suction motor hose (2). Verify that the squeegee hose is properly inserted in its locations (3) and (4), also check that the draining hose cap (5) on the front of the machine is closed.

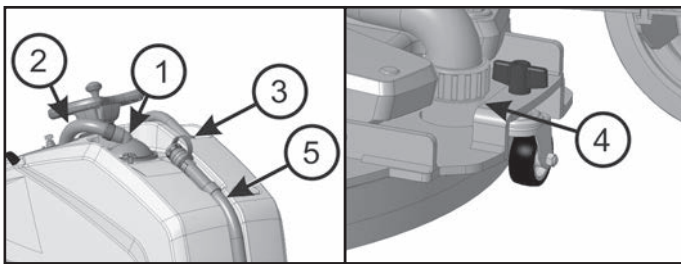

DETERGENT SOLUTION TANK

Grab the hose cap (1) located on the left side of the machine, pull out the hose and after opening the cap, connect the hose to the water valve. Fill the solution tank with clean water at a temperature not over 50°C. Add detergent solution with the concentration provided by the manufacturer. To avoid the excessive production of foam that could cause damages to the suction motor, use a minimum percentage detergent solution.



On the rear part of the machine it is located the water level hose, which allows to see the amount of detergent solution inside the tanks, both when loading it and when working. Screw the detergent solution cap.

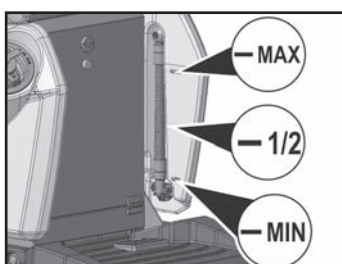

Always use a foam-controlled detergent. To safely avoid the production of foam, before starting to work, add also a small amount of anti-foam solution in the recovery tank.

Never use pure acids.

3S "SOLUTION SAVING SYSTEM" (OPTIONAL)

Is a system that allows the controlled use of the detergent solution during the work.

To activate it press button (1), then the water symbol on the display will start to blink. Select the 3S system using the buttons (2).

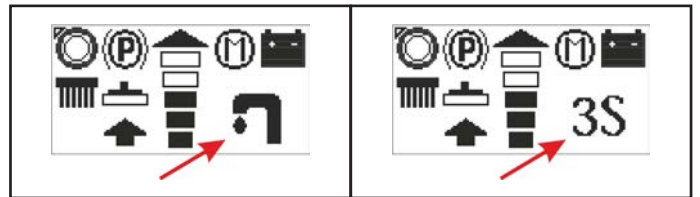
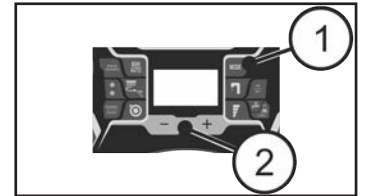

When the 3S system stops to blink, the system is being selected.

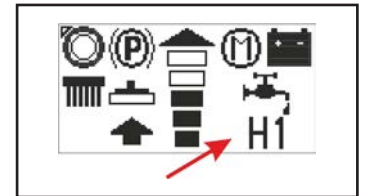

3SD "SOLUTION SAVING SYSTEM DISPENSER" (OPTIONAL)

Is a system that allows a pre-defined dosing of the percentage of detergent solution that is going to mix with the water coming from the solution tank.

The detergent is stored in a 7 liters capacity tank, placed in the rear part of the machine. To fill the detergent, unscrew the cap shown in the drawing.

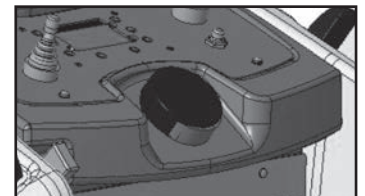

To activate it press button (1), the water symbol will blink on the display. Select the 3SD system using the buttons (2).

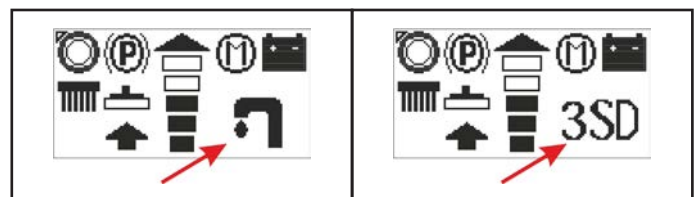
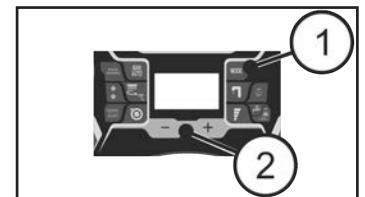

When the 3SD system stops to blink, the system is being selected.

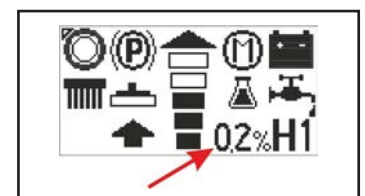

WATER CARRIAGE LEVEL SELECTION – 3S AND 3SD SYSTEM

Pressing the level selection button (1), the H value can be adjusted from H1 to H7.

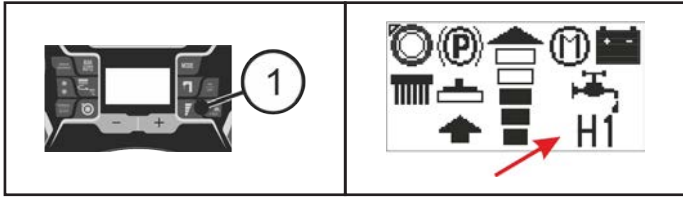

The detergent solution leak permission is given by the solenoid valve button (2).

In manual mode, if the detergent solution is disabled the display will show the disabled solenoid valve symbol.

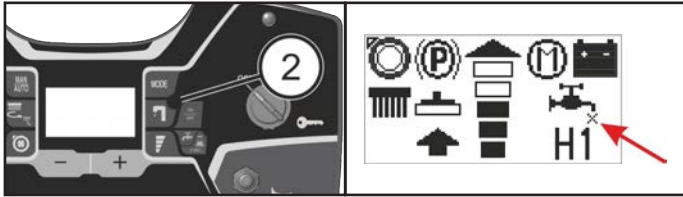

DETERGENT SOLUTION PERCENTAGE SELECTION – 3SD SYSTEM

A pump defines 6 fixed detergent solution percentages: 0.0%, 0.3%, 0.6%, 1.2%, 2.4%, 4.5%.

Using 0,0% the machine cleans using only the water.

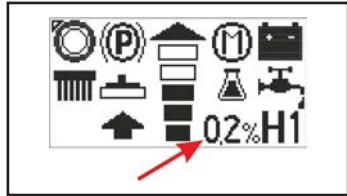

The different detergent solution percentages are selectable by pressing for a few seconds the level button (1), until the value on the display starts to blink.

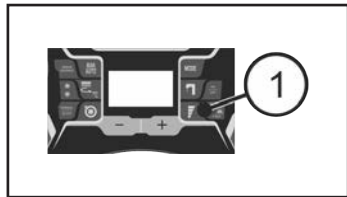

Then the navigation buttons have to be pressed (2) in order to select the wanted value. After a few seconds the value stops to blink.

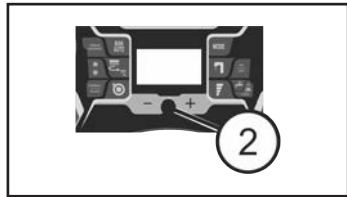

Now the selection is done and pressing eventually the button will modify the water carriage.

OZONE SELECTION (OPTIONAL)

The machine can produce water with an ozone level high enough to disinfect the surfaces cleaned.

To activate it, press button (1), on the display the water icon will blink.

Select the ozone system using the navigation buttons (2).

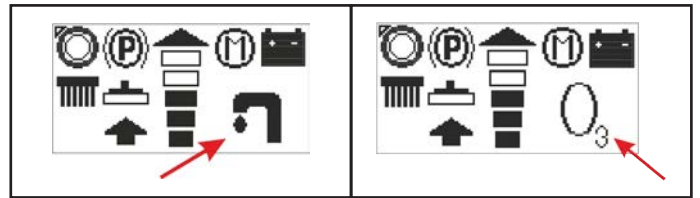
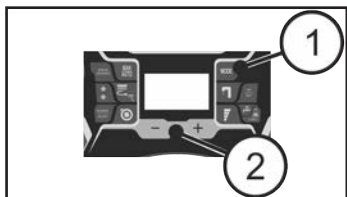

When the O3 icon stops blinking the system is being selected.

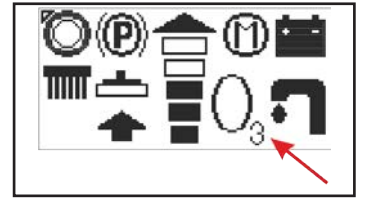

WORKING WITH OZONE (OPTIONAL)

In order to operate the ozone system the best way, proceed as follows:

1. Make sure that the inside of the solution tank is clean, eventually rinse it making at least a couple of fillings and depletions.
2. Fill the solution tank with tap water (do not add any detergent).
3. Select cleaning with ozone, see under "OZONE SELECTION".
4. Start working.

Ozone production is instantaneous and is produced only when water is dispensed. During the work, the system symbol blinks during the Ozone production.

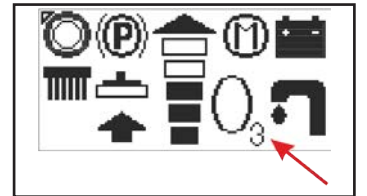

Ozone is a very penetrating gas and it can be irritating.

The ozonated water is strongly oxidizing, therefore in order to protect from oxidization (rust) the metal parts of the machine, it is better to rinse with water all the lower parts of the machine at least once a week.

At the end of the work, it is not necessary to empty the solution tank.

WORK

A safety device prevents the machine's movement if the operator is not properly placed on the footboard.

To turn on the machine:

1. Step on the footboard.
2. Turn the key (1) clockwise to turn on the machine.
3. Check the battery level on the display.
The machine will go automatically in manual mode (MAN).
4. Select the driving direction using the lever (2).

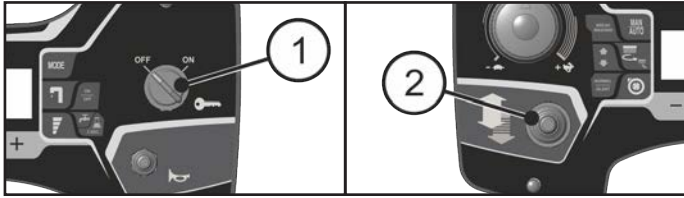

MANUAL MODE WORK

1. Check that the machine is set in manual mode, if not press button (1) and the display will show the corresponding symbol.

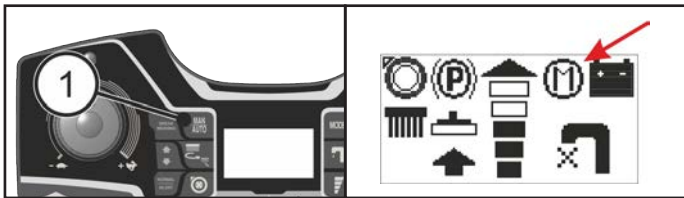

2. Press the suction motor button (2); the suction motor symbol changes depending if the motor is turned on or off, the motor will then start to work.

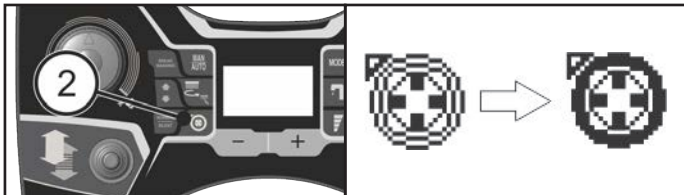

3. Press the solenoid valve button (3); the solenoid valve symbol changes depending if the valve is closed or open.

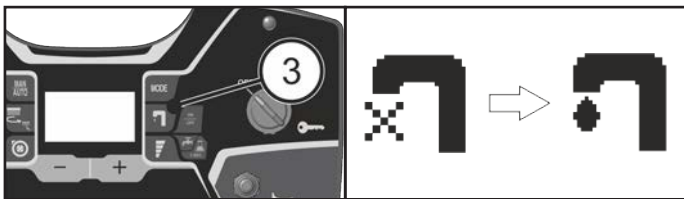

4. Lower the brush base on the floor pressing button (4); the display will show first the lifting down symbol and then the brush on symbol.

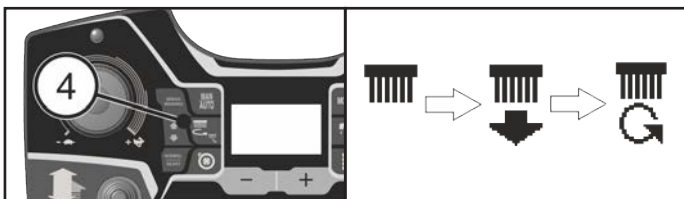

5. Lower the squeegee using the lever (5).

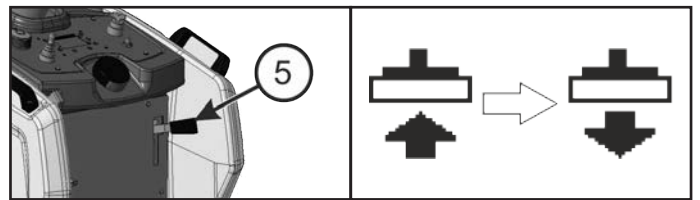

6. While running the first meters check that the squeegee adjustment guarantees a perfect drying action and that the detergent solution flow is appropriate. It has to be sufficient to wet the floor uniformly avoiding the leakage of detergent from the splash guards. Always consider that the correct quantity of solution detergent depends on the type of floor, dirtiness and machine speed.

SPEED ADJUSTMENT, FORWARD AND BACKWARD

Before running the machine select the maximum speed level during work. Press buttons (+) and (-) to see the speed level on the display.

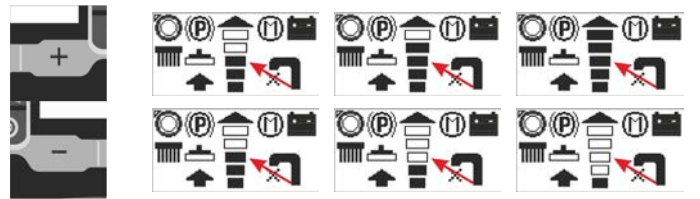

To move the machine select the direction using the lever (1) placed on the dashboard.

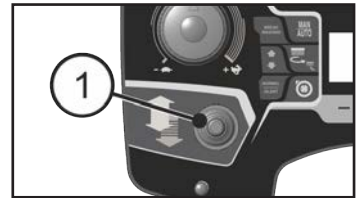

Press the pedal (2) placed on the footboard to enable the drive.

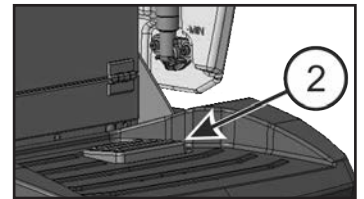

Use the knob (3) to adjust the speed during work. The speed will change from the minimum to the maximum previously set and visible on the display.

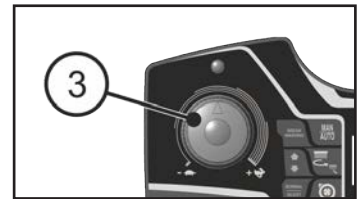

When working it is necessary to lift the squeegee to enable the backward drive.

DETERGENT SOLUTION FLOW ADJUSTMENT

1. Turn the valve knob (1) to adjust the detergent solution flow rate.
2. On the 3S equipped models (optional) It is necessary to press the dedicated button to activate the detergent solution supplying selecting between the tradition mode using the valve or the optimal fixed supply system (see chapter "3S Solution Saving System").

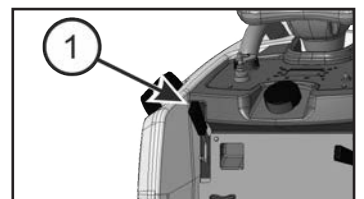

In standard mode the detergent solution flow adjustment is made through the lever (1) both in MAN and AUTO mode.

In 3S and 3SD mode the detergent solution flow adjustment is made as specified in chapter "WATER CARRIAGE LEVEL SELECTION - 3S AND 3SD SYSTEM", and it depends on the current speed. In the 3S and 3SD mode the lever (1) has no use.

AUTOMATIC MODE WORK

1. Automatic mode is helpful to ease the operator work.
2. Check that the machine is set in automatic mode, if not press button (1) and the display will show the corresponding symbol.

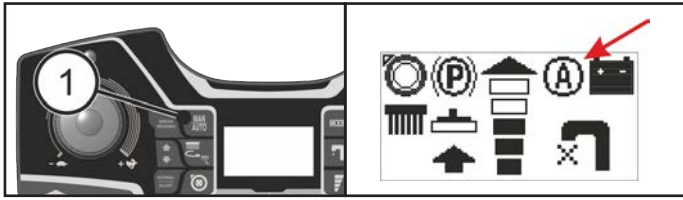

3. lower the squeegee using the lever (2).
4. Press the drive pedal (3) on the footboard.

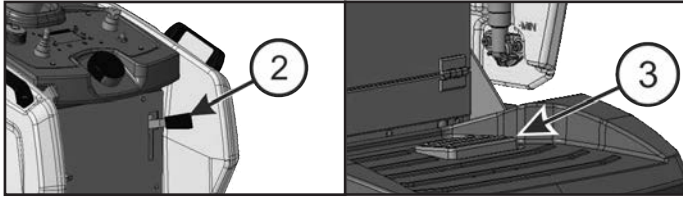

Once the pedal is pressed the machine runs forward, the brush base goes down and simultaneously the squeegee goes down, then the solenoid valve opens itself and brushes and suction motor start working. Before running the machine it is possible to set the brushes pressure and the water and/or detergent solution flow rate (3S and 3SD versions). The values set will show immediately on the display. To adjust the detergent flow see under "DETERGENT SOLUTION FLOW RATE ADJUSTMENT".

After releasing the pedal: the brush base goes up, the brushes motors stop, the solenoid valve closes itself, the suction motor shuts off and the squeegee goes up.



If, during the work in manual mode:

- the brush base, solenoid valve or suction motor is pressed, the machine switch to manual mode;
- the squeegee lever is lifted, the suction motor shuts off after a few seconds; when the lever is lowered the suction motor shuts back on.

SILENT MODE SUCTION MOTOR

It is possible to start the silent mode of the suction motor by pressing for a few seconds the switch-on button (1) of the suction motor. When the silent mode is on the symbol on the display changes.

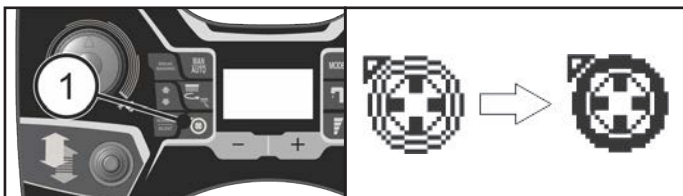

STAND-BY MODE

After 10 minutes of inactivity, if the machine is on, it goes in stand-by mode and the display turns off. To start again press any button on the instrument board, the display will turn on again and after a few seconds the machine returns operative.

HORN

The machine is provided with a horn that can be activated pressing button (1).



PARKING BRAKE

The machine is equipped with a parking brake on the traction motor wheel that operates at the complete release of the pedal or when the machine is without batteries. In case of an emergency or simply to stop the machine, it is sufficient to release the pedal. The brake remains inserted up to when the pedal is pressed again. When the batteries are connected and when the key switch is positioned on 1, on the display the brake signal comes on.

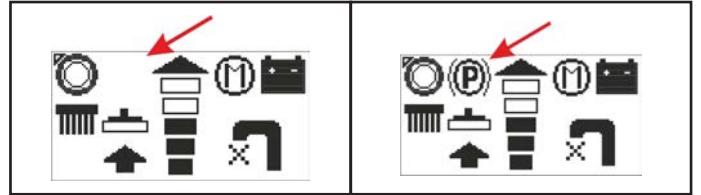

BRUSHES MOTOR OVERLOAD PROTECTION SYSTEM

The machine is equipped with a protection device of the brushes motor. This device blocks the motor functioning in order to protect it and indicates the overload on the display with the message "ALARM 1". When this happens, try to reduce the brushes pressure (see under "ADJUSTMENT OF THE BRUSHES PRESSURE"). If the problem persists, contact the authorized technical assistance.

OVERFLOW SYSTEM



In order to avoid serious damages to the suction motor, the machine is equipped with a float that intervenes when the recovery tank is full. When this happens, it is necessary to empty the recovery tank. Hold the exhaust hose of the machine. Take off the plug and empty the recovery tank into appropriate containers, according to the standard norms.

MACHINE STOP AFTER CLEANING OPERATION

BREAK WASHING MODE

IN AUTOMATIC OR MANUAL WORKING MODE:

1. At the end of the washing cycle, keeping the button (1) pressed, the functioning of BREAK WASHING is chosen.
2. When the mode is on, BREAK WASHING is shown on the display.



This way automatically the brushes lift, the solenoid valve shuts down and it is possible to finish the drying operation for a total time of about 15 seconds, afterwards also the squeegee is lifted and the suction stops.



NOTE: all these phases are carried out with the machine operating, so that the squeegee can dry the interested cleaning area from the "drying phase of the brushes" and furthermore can dry the suction hose of its dirty water.

At any time it is possible to interrupt the procedure BREAK WASHING by stopping the drive.

During the BREAK WASHING, if the drive pedal is released for more than 3 seconds the machine will automatically switch to manual mode (MAN).



The mode (BREAK WASHING) is specific for the transfer at the end of the cleaning operation.

DRAINING AND CLEANING THE DETERGENT TANK (3SD)



Only for machines equipped with optional 3SD system.

If it is necessary to clean with another type of detergent or if you want to leave the machine stopped for long periods, the detergent contained in the appropriate tank needs to be drained.

To empty the tank:

1. Hold the exhaust hose (1) placed on the right side of the machine after having removed it from its fixing support.
2. Open the solution valve (2) of the exhaust hose located on it and empty the tank into the recovery container for the detergent.
3. Rinse the tank with a water jet.
4. Once it has been completely emptied, close the solution valve (2).

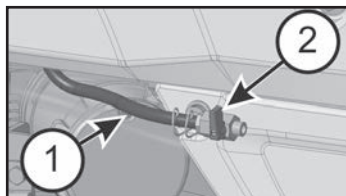

DAILY MAINTENANCE

DRAINING AND CLEANING THE RECOVERY TANK



1. Hold the exhaust hose placed on the front part of the machine after having taken it off from its fixing support.
2. Take off the plug from the exhaust hose acting upon its lever and empty the recovery tank into appropriate containers, in compliance with the respective rules what the liquid disposal concerns.
3. Clean the inside of the tank using a water jet.

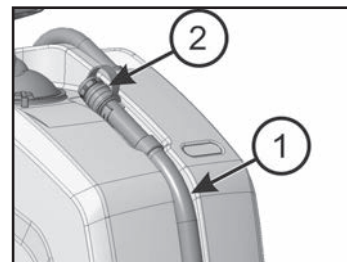

DRAINING AND CLEANING THE SOLUTION TANK



1. Hold the exhaust hose (1) placed on the right side of the machine after having removed it from its fixing support.
2. Open the solution valve (2) of the exhaust hose located on it and empty the solution tank into appropriate containers, in compliance with the respective rules what the liquid disposal concerns.
3. Rinse the tank with a water jet.
4. Once it has been completely emptied, close the solution valve (2).

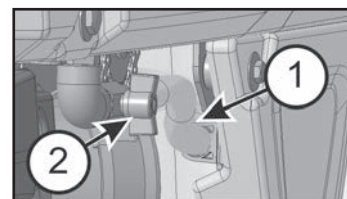

CLEANING THE SUCTION FILTER



1. Open the cover (1) and unscrew the knob (2) to release the filter protection (3).
2. Rotate the filter protection clockwise to release it.
3. Take off the filter and its protection.
4. Clean with a water jet especially the bottom part and the sides of the filter.
5. Do the cleaning procedure precisely.

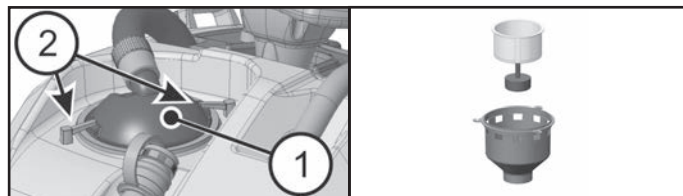

6. Reassemble the filter.

AUTOMATIC DISASSEMBLING OF THE BRUSH



1. Put the lever in central position.
2. Turn on the machine turning the key clockwise (2).
3. Keep the button pressed for a few seconds (3).

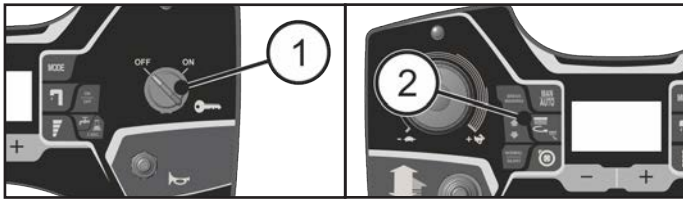

4. Turn off the machine..

CLEANING THE BRUSH



Take off the brush to clean IT with a water jet (to read how to do it see chapter "DISASSEMBLING THE BRUSH").

CLEANING THE SQUEEGEE



Keeping the squeegee clean ensures a better floor cleaning:

1. Lift the brush base, then rotate the squeegee on the side.
2. With the squeegee in such position, take off the squeegee hose coupling (1).
3. Completely unscrew the wing nuts (2) in order to release the squeegee.
4. Carefully clean the joint of the squeegee cleaning eventual dirt deposits and carefully clean also the squeegee rubbers..

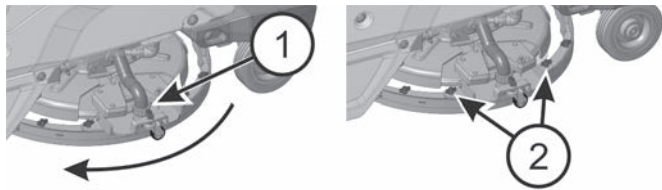

WEEKLY MAINTENANCE

REAR SQUEEGEE RUBBER CHECK



Check the squeegee rubber wearing and eventually turn it or replace it. For the replacement it is necessary:

1. Take off the squeegee (see chapter "CLEANING THE SQUEEGEE").
2. Unlock the squeegee blade lock (1).
3. Take off the rubber to turn it around or replace it.

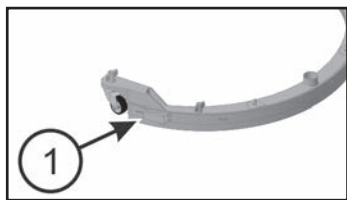

To put back the squeegee just repeat these operations backwards.

CLEANING THE SQUEEGEE HOSE



Weekly or in case of insufficient suction, it is necessary to check that the squeegee hose is not obstructed. Eventually, to clean it, proceed as follows:

1. With the brush base lifted, rotate the squeegee on one side.
2. With the squeegee in such position, take off the squeegee hose coupling (1).

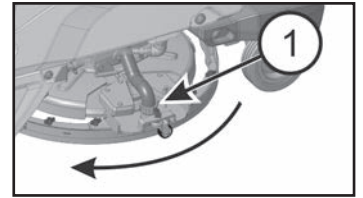

Do not wash the hose that goes from the suction motor to the recovery tank.

CLEANING THE OUTER FILTER AND THE SOLUTION TANK



Take the machine to the place assigned for the detergent solution draining.

Unscrew the detergent solution cap.

1. Unscrew the filter cap (1) and take the filter out.
 2. Wash the filter components with a water jet.
- Once finished to clean, close the valve and the tank cap, then reassemble the filter.

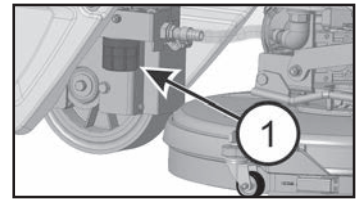

SQUEEGEE HEIGHT ADJUSTMENT

The squeegee height has to be adjusted depending on how much the rubbers are worn. In order to grant an optimal drying, the lower edge of the rear squeegee rubber (1) must be slightly bent backward in a plain way along all its length.

To adjust the rubber bending proceed as follows:

Loose the knob (2) for each wheel that we want to adjust.

Turn the wheel ferrule clockwise in order to decrease the bending or counterclockwise to increase the bending of the rubber.

Lock the knob keeping the ferrule steady.

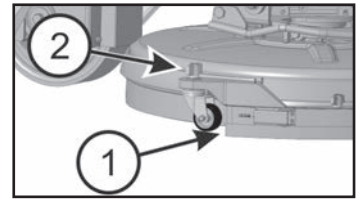

CLEANING THE FILTER (3S OR 3SD VERSION)



The machine with 3S or 3SD system is provided with two filters: one for the standard waterwork (see chapter "CLEANING THE OUTER FILTER AND THE SOLUTION TANK") and one for the 3S or 3SD system. To clean this filter proceed as follows:

1. Close the valve (1).
2. Unscrew the filter cap and take the filter our.
3. Wash the filter components with a water jet.

Once finished to clean put the filter back in and completely open the valve.

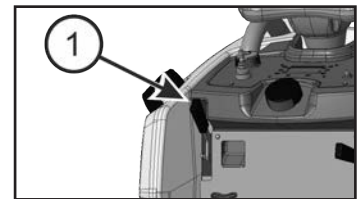

TWO-MONTHLY MAINTENANCE

FRONT SQUEEGEE RUBBER CHECK



Check the wear of the squeegee rubber and eventually replace it.

For the replacement it is necessary to:

1. Take off the squeegee (see under paragraph "SQUEEGEE CLEANING").
2. Disassemble the rear part of the squeegee (see under paragraph "REAR SQUEEGEE RUBBER CHECK").
3. Unscrew the wing nuts (1) and take off the front rubber holder blade (2).
4. Replace the front rubber (3).

To reassemble the squeegee repeat backwards the operations above mentioned.

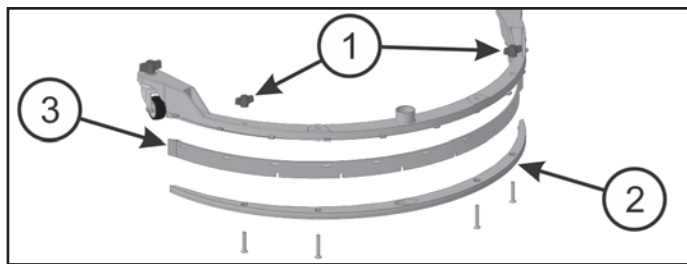

SIX-MONTHLY MAINTENANCE

SPLASH GUARDS RUBBER CHECK

With the brushes assembled, the splash guards must slightly touch the floor. If they are worn, they have to be replaced. Just release the lever coupler placed in the rear part of the brushes base group from the ring placed at the free extremity of the metal strip to take off the rubbers and to reinsert the new ones (see under paragraph "SPLASH GUARD ASSEMBLY"). This operation has to be carried out for both splash guards").

TROUBLESHOOTING GUIDE



The checking of all the other foreseen machine operations is left to the authorized technical assistance.

Never leave the batteries completely discharged for a long time.

In case of alarm visualizations contact the technical assistance.



If with the key switch positioned clockwise to switch on the machine the display and other functions are not activated, it is necessary to check the batteries' connection to the machine (see under paragraph "CONNECTION BATTERIES' CONNECTION AND SWITCHING ON OF THE MACHINE"). If the problem persists, please contact the authorized technical assistance.

If on the display those symbols are shown, it means that the parking brake is not engaged. In this situation all the functions of the machine are disabled. To enable the parking brake see chapter "UNPACKING AND MANUALLY MOVE THE MACHINE" chapter at point 5.

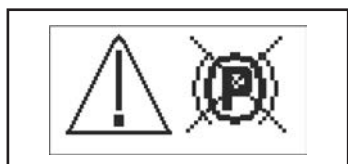

THE SUCTION MOTOR DOES NOT WORK

1. Check the battery charge on the display.
2. Check on the display that the starting signal of the suction motor is on.
3. Check the suction motor connections.

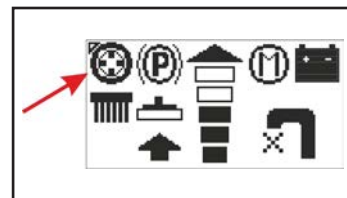

If the problem persists, please contact the authorized technical assistance.

THE BRUSH MOTOR DOES NOT WORK

1. Check the battery charge on the display.
2. Check on the display that the starting signal of the brush motor is on.
3. Press the pedal on the footboard (1) to start the machine.

If the problem persists, please contact the authorized technical assistance.



THE TRACTION MOTOR DOES NOT WORK

Check the lever position (1).

If alarms are showed on the display it is necessary to turn off and the on the machine to restore its functions.

Check the battery charge on the display.

Press the pedal on the footboard (2) to start the machine.

If the problem persists, please contact the authorized technical assistance.



THE SOLUTION IS NOT SPILLED ON THE BRUSH

The machine is equipped with a solenoid valve so to let the solution go down onto the brush it is necessary to make the brush turn.

1. Check on the display that the solenoid valve is activated.
2. Check that the valve lever is open (1). (Standard mode) or that the solenoid valve is activated (3S or 3SD mode).
3. Check the detergent solution level in the solution tank.
4. Check that the solution filter is clean (see under paragraph "CLEANING THE OUTER SOLUTION FILTER").

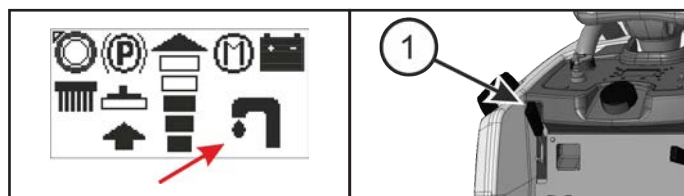
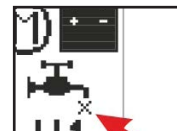

If the problem persists, please contact the authorized technical assistance.

THE MACHINE DOES NOT CLEAN PROPERLY

1. The brushes do not have the suitable bristle dimension: contact the authorized technical assistance.
2. The brushes have got worn bristles. Check the brushes wear condition and eventually replace them (the brushes have to be replaced when the bristles have reached a height of about 15mm).
3. To replace the brushes, see instructions under paragraph "BRUSHES DISASSEMBLY" and "BRUSHES ASSEMBLY".
4. The detergent solution is insufficient: open more the solution valve (see under paragraph "FLOW ADJUSTMENT OF THE DETERGENT SOLUTION").
5. Check that the liquid detergent is in the recommended percentage.
6. Increase the brushes base pressure (see under paragraph "ADJUSTMENT OF THE BRUSHES PRESSURE").

Contact the authorized technical assistance for advice

THE SQUEEGEE DOES NOT DRY PROPERLY

1. Check that the squeegee rubbers are clean.
2. Check the adjustment of the height and the inclination of the squeegee (see section "ADJUSTMENT OF THE SQUEEGEE" in "BEFORE USE").
3. Check that the suction hose is correctly inserted in the proper location on the recovery tank or that it is not clogged.
4. Clean the suction filter.
5. Replace the rubbers if worn out.
6. Check on the display that the starting signal of the suction motor is on.
7. Put the motor in standard mode if silenced.
8. Check that the suction motor cap is closed properly.
9. Check that the recovery tank is not full, hence closing the floater.

If the problem persists, please contact the authorized technical assistance.

EXCESSIVE FOAM PRODUCTION

Check that low foam detergent has been used. Eventually add small quantities of anti foam liquid into the recovery tank. Please consider that a major foam production happens when the floor is slightly dirty. In that situation please dilute further the detergent solution.

PROGRAMMED MAINTENANCE

PERIODIC ORDINARY MAINTENANCE CHART

INTERVENTION	DAILY	PERIODIC
RECOVERY TANK CLEANING	•	
SUCTION FILTER CLEANING	•	
SOLUTION TANK FILTER CLEANING		•
BRUSHES CLEANING	•	
BRUSHES DISASSEMBLY AND CLEANING	•	
SQUEEGEE CLEANING	•	
FRONT SQUEEGEE RUBBER CHECK		•
REAR SQUEEGEE RUBBER CHECK		•
SPLASH GUARD RUBBER CHECK		•
CHECK SQUEEGEE ADJUSTMENT		•
SQUEEGEE HOSE CLEANING		•
SOLUTION TANK CLEANING		•
CHECK BATTERIES ELECTROLYTE		•